



TRINIDAD AND TOBAGO GAZETTE

(EXTRAORDINARY)

VOL. 42

Port-of-Spain, Trinidad, Monday 7th July, 2003—Price \$1.00

No. 100

1225

SUPPLEMENT TO THIS ISSUE

THE DOCUMENTS detailed hereunder have been issued and are published as a Supplement to this issue of the *Trinidad and Tobago Gazette*:

Legal Supplement Part B—

Erratum—(In respect of Legal Notice No. 40 of 2003)—(Legal Notice No. 103 of 2003).

Regulated Industries Commission (Approval of Cess) Order, 2003—(Legal Notice No. 104 of 2003).

Notice of submission for public comment on an Environmental Impact Assessment Report prepared by Continental Shelf Associates, Inc. on behalf of Eog Resources Trinidad Limited—(Legal Notice No. 105 of 2003).

1226

APPOINTMENT OF MEMBERS OF THE VICTORIA (EAST) PRINCES TOWN LOCAL PUBLIC ASSISTANCE BOARD

IT IS NOTIFIED for general information that the undermentioned persons have been appointed by Cabinet to serve as members of the Victoria (East) Princes Town Local Public Assistance Board in accordance with the provisions of section 8 of the Public Assistance Act, Chap. 32:03 of the Laws of the Republic of Trinidad and Tobago for a period of two (2) years with effect from 22nd May, 2003—

Mrs. JENNY BENGOCHEA

Ms. PEARL JAMES

Ms. UMLTA SAUNDERS

V. JONES
*Acting Permanent Secretary,
Office of the Prime Minister
(Social Services Delivery)*

June 2003.

1227

COLLECTION OF LANDS AND BUILDINGS TAXES—DISTRICT REVENUE OFFICE

(Lands and Buildings Taxes Act, Chap. 76:04)



THE PUBLIC is hereby notified that the District Revenue Offices (formerly Wardens Offices) listed hereunder will open for business on extra days in June, 2003 to facilitate the collection of Lands and Buildings Taxes:

<i>Offices</i>	<i>Days</i>	<i>Business Hours</i>
Erin	24th—30th June	9.00 a.m.—2.00 p.m.
Cedros	24th—30th June	9.00 a.m.—2.00 p.m.
Mayaro	23rd—30th June	9.00 a.m.—3.00 p.m.
Biche	23rd—30th June	9.00 a.m.—2.00 p.m.
Moruga	24th—30th June	9.00 a.m.—2.00 p.m.

S. MAHARAJ
*Acting Revenue Officer V,
St. George West, Port-of-Spain*

1228

THE INDUSTRIAL DESIGNS ACT.

<p>Intellectual Property Office Trinidad and Tobago</p> 	<p>Publication Number: TT/D/2003/00001</p> <p>Publication Date: Monday 7th July, 2003</p> <p>International Classification: LC (7) 10-07</p>
<p>INDUSTRIAL DESIGN</p>	
<p>Application Number: TT/F/2000/00006</p> <p>Filing Date: 6 November 2000</p> <p>Priority Number: 2092355</p> <p>Priority Date: 5 May 2000</p> <p>Priority Country: UK</p> <p>Types of products for which the Industrial Design is to be used: Watches.</p>	<p>Owner(s): EBEL SA; 113 rue de la Paix, 2300 La Chaux-de-Fonds, Switzerland.</p> <p>Creator: CHODAT Jean-Pierre; (Swiss Citizen) Grand-Rue 14, 2012 Auvernier, Switzerland.</p> <p>Agent: Messrs. Fitzwilliam, Stone, Furness-Smith & Morgan, 36 Pembroke Street, Port of Spain, Trinidad, W.I.</p>
<p>Title: WATCH CASES</p>	
<p>Representation:</p> 	

1229

THE INDUSTRIAL DESIGNS ACT.

<p>Intellectual Property Office Trinidad and Tobago</p> 	<p>Publication Number: TT/D/2003/00002</p> <p>Publication Date: Monday 7th July, 2003</p> <p>International Classification: LC (7) 04-02</p>
---	--

INDUSTRIAL DESIGN

<p>Application Number: TT/F/1998/00004</p> <p>Filing Date: 12 May 1998</p> <p>Priority Number: 29/079/391</p> <p>Priority Date: 13 November 1997</p> <p>Priority Country: US</p> <p>Types of products for which the Industrial Design is to be used: Toothbrush</p>	<p>Owner(s): COLGATE-PALMOLIVE COMPANY; 300 Park Avenue, New York, New York 10027, United States of America.</p> <p>Creator: MOSKOVICH Robert; 20 Jensen Street, East Brunswick, New Jersey 08816, United States of America. VONARBURG Walter; Weiherstr, 10, 6234 Triengen, Switzerland.</p> <p>Agent: S.A. Kelshall and Company; 11, St Vincent Street, Port of Spain, Trinidad, W.I.</p>
---	--

Title: TOOTHBRUSH

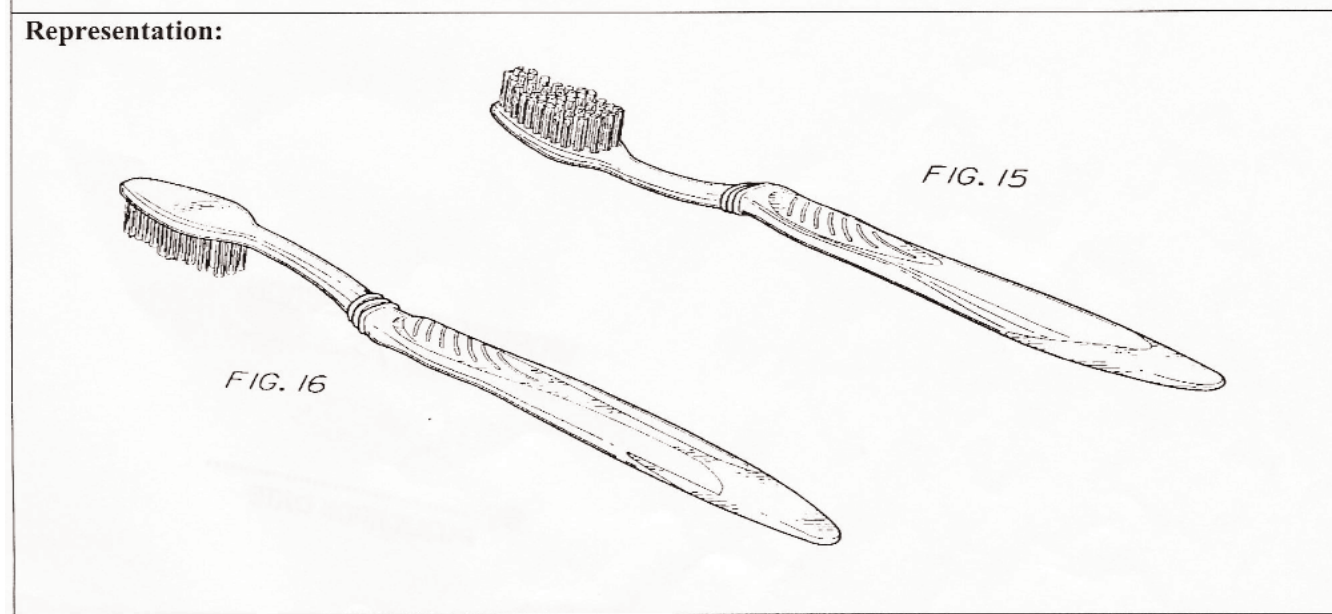

1230

THE INDUSTRIAL DESIGNS ACT.

Intellectual Property Office
Trinidad and Tobago



Publication Number: TT/D/2003/00003

Publication Date:

International Classification: LC (7) 28-01

INDUSTRIAL DESIGN

Application Number:

TT/E/1998/00000

Filing Date:

29 September 1998

Priority Number:

29/086167

Priority Date:

7 April 1998

Priority Country:

United States of America

Types of products for which the Industrial
Design is to be used: Pharmaceutical Tablet

Owner(s): PFIZER RESEARCH AND DEVELOPMENT
COMPANY [NY/SA]; La Touche House, International
Finance Centre, Dublin 1, Ireland.

Creator: BURROWS Robert; Pfizer Central Research,
Ramsgate Road, Sandwich, Kent, CT13 9NL, United Kingdom.

Agent: J. D. Sellier & Co., 129/E31 Abercromby Street, Port
of Spain, Trinidad, W.I.

Title: PHARMACEUTICAL TABLET.

Representation:

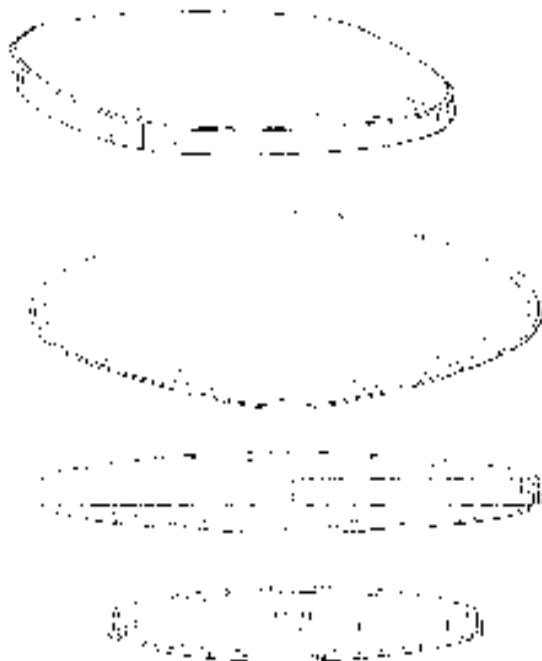

1231

THE INDUSTRIAL DESIGNS ACT.

<p>Intellectual Property Office Trinidad and Tobago</p> 	<p>Publication Number: TT/D/2003/00004</p> <p>Publication Date: Monday 7th July, 2003</p> <p>International Classification: LC (7) 04-02</p>
--	--

INDUSTRIAL DESIGN

<p>Application Number: TT/F/1998/00003</p> <p>Filing Date: 12 May 1998</p> <p>Priority Number: 29/079/393</p> <p>Priority Date: 13 November 1997</p> <p>Priority Country: US</p> <p>Types of products for which the Industrial Design is to be used: Toothbrush</p>	<p>Owner(s): COLGATE-PALMOLIVE COMPANY; 300 Park Avenue, New York, New York 10027, United States of America.</p> <p>Creator: MOSKOVICH Robert; 20 Jensen Street, East Brunswick, New Jersey 08816, United States of America. VONARBURG Walter; Weiherstr, 10, 6234 Triengen, Switzerland.</p> <p>Agent: S.A. Kelshall and Company; 11, St Vincent Street, Port Of Spain, Trinidad, W.I.</p>
---	---

Title: TOOTHBRUSH.

Representation:

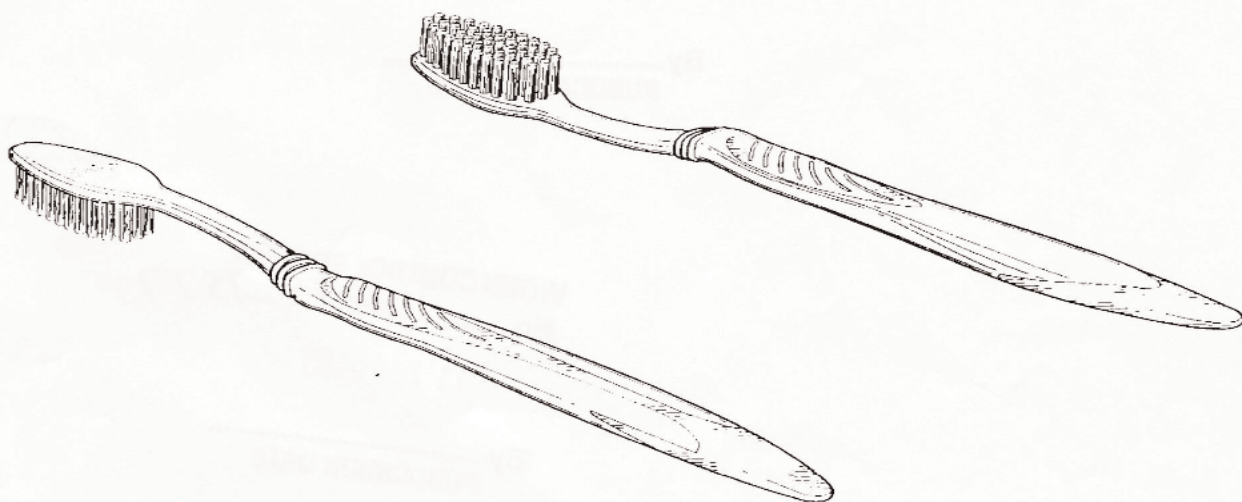

1232

FORM NO. 3 - THE PATENTS ACT.

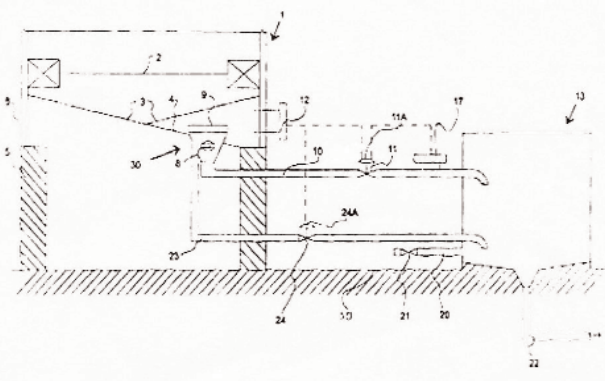
<p>(19) Intellectual Property Office Trinidad and Tobago</p> 	<p>(11) Publication Number: TT/P/2003/00020</p> <p>(45) Publication Date: Monday 7th July, 2003</p> <p>(51) IPC: (6) B01D 17/032</p>
<p>(12) PATENT</p>	
<p>(21) Application Number: TT/A/1999/00027</p> <p>(22) Filing Date: 18 September 1997</p> <p>(31) Priority Number: PI 9605709-2</p> <p>(32) Priority Date: 26 November 1996</p> <p>(33) Priority Country: BRASIL</p>	<p>(73) Owner(s): PETRÓLEO BRASILEIRO S.A. – PETROBRAS [BR/BR]; Avenida República do Chile, 65, Rio de Janeiro (BR).</p> <p>(72) Inventor(s): WITTER, Aldyr; Avenida São Borja, 1200, São Leopoldo, Rio Grande do Sul (BR). SCHILLING, Antonio, Jorge, Leitão; Rua Ulisses Cabral, 590, Porto Alegre, Rio Grande do Sul (BR). DA SILVA, Cláudio, Camilo; Rua Adão José Vargas, 237, São Leopoldo, Rio Grande do Sul (BR). FRANCISCO, Edu, Correia; Rua Rodrigues Alves, 367, Sapucaia do Sul, Rio Grande do Sul (BR). MARINHO, Artur, Rogério, Monteiro; Rua Duque de Caxias, 891, Canoas, Rio Grande do Sul (BR).</p> <p>(74) Agent: J. D. Sellier & Co., 129/131 Abercromby Street, Port of Spain, Trinidad, W.I.</p>
<p>(54) Title: SYSTEM FOR DRAINING A LIQUID STORAGE TANK</p>	
<p>(57) Abstract: The present invention relates to a system which makes it possible to remove undesirable liquids, generally an aqueous phase, which precipitate to the bottom of tanks for storing liquid products. Use is made of a drainage device (30) which comprises a concave body (31), a seat (26), and an interface float (8) which has a plug portion (25). This interface float (8) is designed to sink into the product and to float on the aqueous phase. As the level of the aqueous phase drops, the plug portion (25) settles sealingly on the seat (26), halting the drainage operations since all the accumulated aqueous phase has already been drained off. The drainage system may be automatic or manual.</p> <p>In the former case, use is made of a sensor (12) for detecting the presence of an aqueous phase and commanding the process of opening a shut-off valve (11) and allowing drainage of the accumulated aqueous phase. In the manual case, an operator periodically checks for the presence of an aqueous phase inside de storage tank (1), through a port (28) for inspecting the level. If such a phase were to accumulate, he opens a manual shut-off valve (29) so as to allow all the accumulated aqueous phase to drain away.</p>	

1233

FORM NO. 3 - THE PATENTS ACT.

<p>(19) Intellectual Property Office Trinidad and Tobago</p> 	<p>(11) Publication Number: TT/P/2003/00035</p> <p>(45) Publication Date: Monday 7th July, 2003</p> <p>(51) IPC: (6) B65B 1/36</p>
---	---

(12)	PATENT
------	--------

<p>(21) Application Number: TT/A/2000/00016</p> <p>(22) Filing Date: 6 October 1998</p> <p>(31) Priority Number: 08/949,047</p> <p>(32) Priority Date: 10 October 1997</p> <p>(33) Priority Country: UNITED STATES OF AMERICA</p>	<p>(73) Owner(s): INHALE THERAPEUTIC SYSTEMS [US/US]; 150 Industrial Road, San Carlos, CA 94070 (US).</p> <p>(72) Inventor(s): STOUT, Gordon; 401 Evelyn #27, Albany, CA 94706 (US). PHAM, Xuyen; 114 Lurene Drive, Fremont, CA 94541 (US). ROCCHIO, Michael, J.; 2542 Jacob Street, Hayward, CA 94541 (US). NAYDO, Kyle, A.; 902 Rockerfeller Drive, 3A, Sunnyvale, CA 94087 (US). PARKS, Derrick, J.; 1535 White Oak Way, San Carlos, CA 94070 (US). REICH, Patrick; 1555 W. Hillsdale Boulevard #110, San Mateo, CA 94402 (US).</p> <p>(74) Agent: Messrs. Fitzwilliam, Stone, Furness-Smith & Morgan, 36 Pembroke Street, Port of Spain, Trinidad, W.I.</p>
--	--

(54) Title: POWDER FILLING APPARATUS AND METHOD
--

(57) **Abstract:** The invention provides methods, systems and apparatus for the metered transport of fine powders into receptacles. According to one exemplary embodiment, an apparatus is provided which comprises a hopper (12) having an opening. The hopper is adapted to receive a bed of fine powder (20). At least one chamber (24), which is moveable to allow the chamber to be placed in close proximity to the opening, is also provided. An element (28) having a proximal end and a distal end is positioned within the hopper such that the distal end is near the opening. A vibrator motor is provided to vibrate the element when within the fine powder.

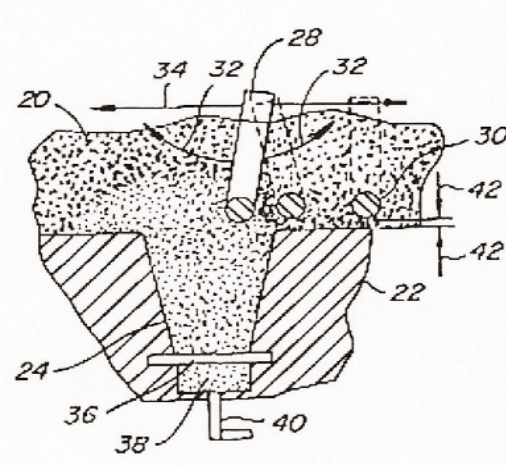

1234

FORM NO. 3 - THE PATENTS ACT.

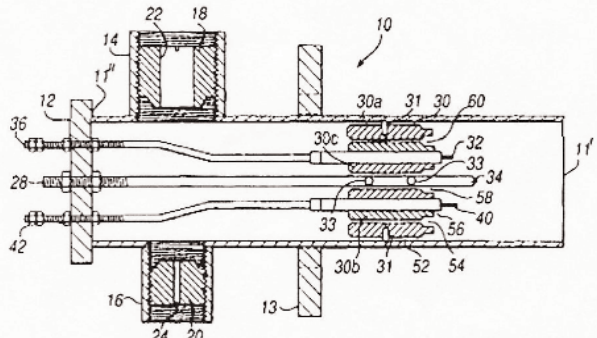
<p>(19) Intellectual Property Office Trinidad and Tobago</p> 	<p>(11) Publication Number: TT/P/2003/00036</p> <p>(45) Publication Date: Monday 7th July, 2003</p> <p>(51) IPC: (6) F23D 14/62, F23D 14/02, 14/60, 14/74</p>
<p>(12) PATENT</p>	
<p>(21) Application Number: TT/A/2000/00021</p> <p>(22) Filing Date: 16 June 1999</p> <p>(31) Priority Number: 9812975.2</p> <p>(32) Priority Date: 16 June 1998</p> <p>(33) Priority Country: GB</p>	<p>(73) Owner(s): GRAVESON ENERGY MANAGEMENT LTD. [GB/GB]; Keer Bridge House, Warton, Carnforth, Lancashire LA5 9HA (GB).</p> <p>(72) Inventor(s): MATON, Maurice, Edward, George [GB/GB]; Busketts House, Busketts Way, Ashurst, Hants SO40 7AE (GB). ????</p> <p>(74) Agent: J. D. Sellier & Co., 129/131 Abercromby Street, Port of Spain, Trinidad, W.I.</p>
<p>(54) Title: BURNER</p>	
<p>(57) Abstract: A burner for combusting gaseous mixture of gaseous fuel with a combustion supporting gas, such as oxygen or air, comprising a burner tube (11) open at one end (11') and closed at its other end (11'') with a flame holder (30) at which fuel is burnt adjacent the open end (11'), the flame holder (30) being traversed by passageways (52, 54, 56, 58) for the gaseous mixture, the burner (10) having inlets (14, 16) adjacent the closed end (11'') connected to combustion supporting gas and gaseous fuel supply lines, one of said lines having a control valve operable for controlling the size of the flame, the said one line having a pressure or flow transducer and the other line having a variable booster or restrictor responsive to the transducer, for balancing air and fuel supplied to the burner (10) to ensure the gaseous mixture remains stoichiometric irrespective of the size of the flame and such that the lowest gaseous fuel mixture flow rate is at least as low as 1/60th the highest flow rate of the gaseous fuel mixture each passageway (52, 54, 56, 58) having a flared exit (60) at the end nearer the open end (11') of the burner (11) each passageway being dimensioned such that at the highest obtainable flow rate of gaseous fuel mixture the flames do not lift off from the flamer holder, at the lowest flow rate the velocity of the gaseous fuel mixture at some point within the passageway (52, 54, 56, 58) is sufficient to prevent flame back through the flame holder.</p> 	

1235

FORM NO. 3 - THE PATENTS ACT.

<p>(19) Intellectual Property Office Trinidad and Tobago</p> 	<p>(11) Publication Number: TT/P/2003/00037</p> <p>(45) Publication Date: Monday 7th July, 2003</p> <p>(51) IPC: (7) F27D 3/00, F27D 3/10, B65G 53/46</p>
<p>(12) PATENT</p>	
<p>(21) Application Number: TT/A/2001/00080</p> <p>(22) Filing Date: 29 April 2000</p> <p>(31) Priority Number: 199 50 101.7</p> <p>(32) Priority Date: 18 October 1999</p> <p>(33) Priority Country: Germany</p>	<p>(71) Applicant(s): MG TECHNOLOGIES AG [DE/DE]; Bockenheimer Landstrasse 73-77, D-60325 Frankfurt am Main (DE).</p> <p>(72) Inventor(s): DEPPE, Rüdiger [DE/DE]; Schottener Strasse 5, D-60435 Frankfurt am Main, Germany.</p> <p>(74) Agent: J. D. Sellier & Co., 129/131 Abercromby Street, Port of Spain, Trinidad, W.I.</p>
<p>(54) Title: METHOD OF CHARGING A PRESSURIZED CONTAINER WITH GRANULAR SOLIDS</p>	
<p>(57) Abstract: The invention relates to a method of charging a pressurized container with granular solids. According to the inventive method, the solids are first guided into a first container (10) that is subjected to an atmospheric pressure and then into a second container (20) that is located below said first container and that is subjected to a variable pressure before the pressurized container is charged with said solids. Said first and said second container have respective lower outlet channels (11) and a movable slide (2) that interacts with said outlet channels. The outlet end of the outlet channel (11) is located 20 to 400 mm above the slide (2) in the closed position and the slide, in the closed position, forms the bottom of a chamber (13) that is at least partially filled with solids. Said chamber is linked with the outlet channel in a gas-tight manner. The chamber and the slide are not shut off from each other in a gas-tight manner. The slide carries bulk solids (14) in the closed position. The outlet channel (11) and the container (10) contain a vertical solids column of at least 1 m height. In the closed position, seal gas (12) is forced from outside into the chamber and into the solids column.</p>	

1236

FORM NO. 3 - THE PATENTS ACT.

<p>(19) Intellectual Property Office Trinidad and Tobago</p> 	<p>(11) Publication Number: TT/P/2003/00038</p> <p>(45) Publication Date: Monday 7th July, 2003</p> <p>(51) IPC: (6) A61K 47/30, A61K 47/12, 38/24</p>
<p>(12) PATENT</p>	
<p>(21) Application Number: TT/A/2000/00097</p> <p>(22) Filing Date: 13 January 1999</p> <p>(31) Priority Number: 10/6412</p> <p>(32) Priority Date: 16 January 1998</p> <p>(33) Priority Country: JP</p>	<p>(73) Owner(s): TAKEDA CHEMICAL INDUSTRIES, LTD. [JP/JP]; 1-1, Doshomachi 4-chome, Chuo-ku, Osaka-shi, Osaka 541-0045 (JP).</p> <p>(72) Inventor(s): SAIKAWA, Akira [JP/JP]; Iwata Building, 3rd floor, 2-45, Nagaoka 2-chome, Nagaokakyo-shi, Kyoto 617-0823 (JP). IGARI, Yasutaka [JP/JP]; 4-25-503, Motoyamaminamimachi 5-chome, Higashinada-ku, Kobe-shi, Hyogo 658-0015 (JP). HATA, Yoshio [JP/JP]; 1-12-703, Kitamidorigaoka 2-chome, Toyonaka-shi, Osaka 560-0001 (JP). YAMAMOTO, Kazumichio [JP/JP]; 7-10-116, Ayameikeminami 1-chome, Nara-shi, Nara 631-0033 (JP).</p> <p>(74) Agent: J. D. Sellier & Co., 129/131 Abercromby Street, Port of Spain, Trinidad, W.I.</p>
<p>(54) Title: SUSTAINED RELEASE COMPOSITIONS, PROCESS FOR PRODUCING THE SAME AND UTILIZATION THEREOF</p>	
<p>(57) Abstract: Sustained release compositions containing a physiologically active substance or its salt, hydroxynaphthoic acid or its salt and a biodegradable polymer or its salt; and drugs, etc. containing these compositions.</p>	

1237

FORM NO. 3 - THE PATENTS ACT.

<p>(19) Intellectual Property Office Trinidad and Tobago</p> 	<p>(11) Publication Number: TT/P/2003/00028</p> <p>(45) Publication Date: Monday 7th July, 2003</p> <p>(51) IPC: (6) E21B 43/25, C09K 7/02</p>
<p>(12) PATENT</p>	
<p>(21) Application Number: TT/A/1998/00032</p> <p>(22) Filing Date: 09 December 1996</p> <p>(31) Priority Number: 08/572,562</p> <p>(32) Priority Date: 14 December 1995</p> <p>(33) Priority Country: United States of America</p>	<p>(73) Owner(s): BAKER HUGHES INCORPORATED [US/US]; 3900 Essex Lane, Houston, TX 77027 (US).</p> <p>(72) Inventor(s): JACKSON, George, E.; 2 College Road North, Blundell Sands, Liverpool L23 8UP (GB). MCLAUGHLIN, Kevin; Maypole Villa, Ring O'Bell, Lathom, Ormskirk, Lancashire L40 5TF (GB). POYNTON, Neil; 84 Lighthurst Lane, Chorley, Lancashire PR7 3EQ (GB). PRZYBYLINSKI, John, L.; 501 West Adams, St. Louis, MO 63119 (US).</p> <p>(74) Agent: Messrs. Fitzwilliam, Stone, Furness-Smith & Morgan; 36 Pembroke Street, Port of Spain, Trinidad, W.I.</p>
<p>(54) Title: SCALE INHIBITION BY SQUEEZE APPLICATION OF A PHOSPHONOMETHYLATED POLYAMINE INHIBITOR</p>	
<p>(57) Abstract: A method for long term inhibition of scale in a brine downhole in a well. An effective amount of an N-phosphonomethylated polymer of an epihalohydrin and an amine selected from the group consisting of alkylene diamines, di-alkylene triamines and tri-alkylene tetramines, in an epihalohydrin to amine molar ratio of from about 0.6:1 to about 2:1, the polymer having a molecular weight of from about 500 to about 40,000, is squeezed into the well.</p>	

1238

PATENTS

I, MAZINA KADIR, Registrar of Patents and Designs for Trinidad and Tobago, do hereby certify that on TUESDAY THE 19TH DAY OF AUGUST, 1997, has been delivered to me by Kawasaki Jukogyo Kabushiki Kaisha, a Company organized and existing under the laws of Japan, whose trade or business address is at 1-1, Higasikawasaki-cho 3-chome, Chuo-ku, Kobe-shi, Hyogo 650-91, Japan, a Declaration in writing signed by Kawasaki Jukogyo Kabushiki Kaisha, of a certain Invention whereof the said Kawasaki Jukogyo Kabushiki Kaisha, claims to be the Proprietor, being an invention entitled "Process for Producing Iron Carbide and Equipment Therefor" together with a Specification describing the nature of the said Invention, and the manner in which the same is to be performed, and that the name of the said Kawasaki Jukogyo Kabushiki Kaisha, has been entered in the Register of Patents as the Proprietor of this Patent as No. 970098 with effect from 10th March, 1995 the date of filing Application No. 96PX0017 corresponding to PCT/JP96/00608 filed on 11th March, 1996.

In witness whereof I have hereunto subscribed my name at Port-of-Spain, this 19th day of August, 1997.

M. KADIR
Registrar

1239

LOSS OF LIFE OF BARBADOS LIMITED POLICIES

PURSUANT to section 163 of the Insurance Act, 1980, Policy Number U142252 on the life of EARL SANKAR has been reported lost and we hereby give notice of our intention to issue a special policy in replacement thereof within 30 days of this publication.

LIFE OF BARBADOS LIMITED

1240

PURSUANT to section 163 of the Insurance Act, 1980, Policy Number 0132842 on the life of ALSTON BOODRAM has been reported lost and we hereby give notice of our intention to issue a special policy in replacement thereof within 30 days of this publication.

LIFE OF BARBADOS LIMITED

1241

PURSUANT to section 163 of the Insurance Act, 1980, Policy Number U144163 on the life of SUSAN DEONARINE has been reported lost and we hereby give notice of our intention to issue a special policy in replacement thereof within 30 days of this publication.

LIFE OF BARBADOS LIMITED

1242

PURSUANT to section 163 of the Insurance Act, 1980, Policy Number U142097 on the life of ELDON HICKS has been reported lost and we hereby give notice of our intention to issue a special policy in replacement thereof within 30 days of this publication.

LIFE OF BARBADOS LIMITED

1243

PURSUANT to section 163 of the Insurance Act, 1980, Policy Number U147121 on the life of LAURENCE RICHARDSON has been reported lost and we hereby give notice of our intention to issue a special policy in replacement thereof within 30 days of this publication.

LIFE OF BARBADOS LIMITED

1244

LOSS OF MARITIME LIFE (CARIBBEAN) LIMITED POLICY

VISHWAMATIE BOODRAM having made sworn declaration that Policy Number 216478 issued by MARITIME LIFE (CARIBBEAN) LIMITED on the life of VISHWAMATIE BOODRAM has been lost and having made application to the Company for a duplicate policy, notice is hereby given that unless objection is raised within one month of the date thereof, the duplicate policy asked for will be issued.

MARITIME LIFE (CARIBBEAN) LIMITED

29, Tenth Avenue,
Barataria.

1245

SPECIAL LICENSING SESSION
(Liquor Licences Act, Chap. 84:10)

SAN FERNANDO

NOTICE is hereby given that by lawful authority under the provisions of section 18(3) of the Liquor Licences Act, Chap. 84:10, the Licensing Committee for the Licensing District of the County of Victoria (West), San Fernando Area, has appointed THURSDAY THE 24TH DAY OF JULY, 2003 at 9.00 o'clock in the forenoon at the San Fernando Magistrates' Court as the day, hour and place at which a Special Session will be held to consider the application of Carl Semprie of 43, Coffee Street, San Fernando for a Certificate authorising him to obtain a Special Restaurant and Bar Licence in respect of premises situate at 43, Coffee Street, San Fernando.

Dated this 2nd day of July, 2003 at the San Fernando Magistrates' Court.

A. SOOKRAM
*Secretary Licensing Committee,
Victoria (West)*

1246

TRANSFER OF LICENCES
(Liquor Licences Act, Chap. 84:10)

ST. GEORGE EAST

NOTICE is hereby given that a notification in writing has this 26th day of June, 2003 been lodged with me the undersigned Secretary of the Licensing Committee for the Licensing District of the County of St. George East, Tunapuna Area, by Simon Walters of 14, Royal Road, Maracas, St. Joseph, that it is his intention to apply to the Licensing Committee at the Tunapuna Magistrate's First Court on WEDNESDAY THE 16TH DAY OF JULY, 2003 at 9.00 o'clock in the forenoon for a transfer to him of the Licence to carry on the business of a Spirit Retailer now held by Sheila Walters Matamoro, in respect of premises situate at 12, Royal Road, Maracas, St. Joseph.

Dated this 26th day of June, 2003 at the Tunapuna Magistrate's Court.

A. ALI
*Secretary, Licensing Committee,
Tunapuna*

1247

ST. PATRICK WEST

NOTICE is hereby given that a notification in writing has this day been lodged with me the undersigned Secretary of the Licensing Committee for the Licensing District of Point Fortin by Sukdai Phagoo, of 59, Central Road, Point Fortin that it is her intention to apply to the Licensing Committee at the Point Fortin Magistrate's Court on WEDNESDAY THE 9TH DAY OF JULY, 2003 for a transfer of the Licence to carry on the business of a Restaurant in respect of premises situate at No. 5 Warner Road, Point Fortin to the other premises at 622, Southern Main Road, Rousillac, La Brea.

Dated this 4th day of July, 2003 at the Point Fortin Magistrate's Court.

R. SOOKHANSINGH
*Secretary, Licensing Committee,
Point Fortin*